

SHARP

MX-M283N

Digital Multifunctional System

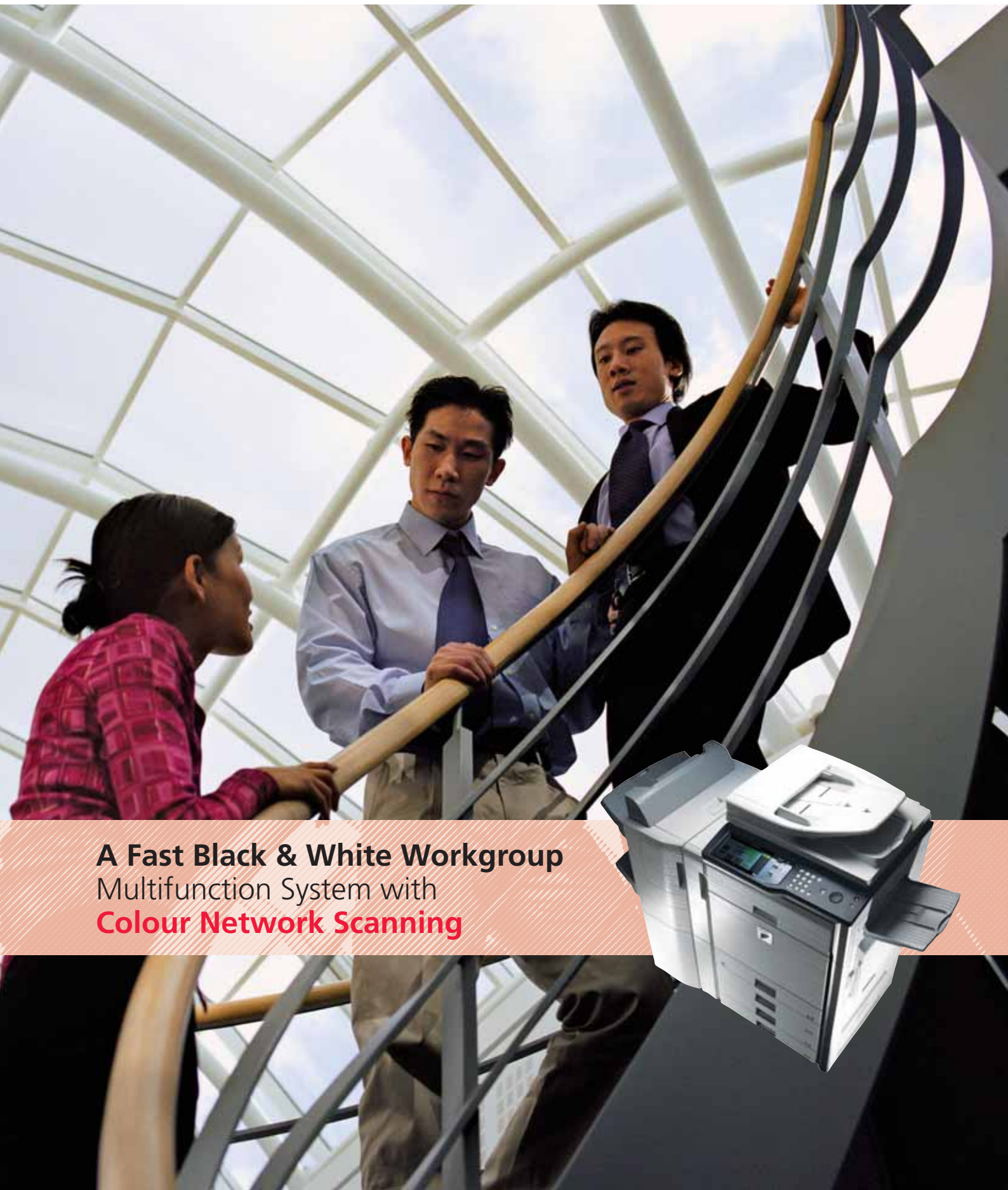

**A Fast Black & White Workgroup
Multifunction System with
Colour Network Scanning**





28 PPM in B/W



Large Colour
Touch-Screen
LCD Display

Adding **performance and productivity** to small and medium workgroups

Combining powerful print, copy and fax features with fast colour network scanning capabilities, the new MX-M283N has all the functionality and speed you need to put it at the heart of your office operations.

And not only does it come with many of the advanced performance features that have made Sharp's colour MFPs so successful, it was specifically designed with ease of use in mind.

A retractable keyboard option makes data entry and emailing quick and simple and there's a large, 8.5" colour touch-screen LCD display with thumbnail views, which can be customised to suit the needs and preferences of each individual user. Now even the most advanced features are instantly and intuitively accessible.

More for your money

IT Administrators will appreciate the Remote Access Interface which simplifies support by letting them view and operate the front panel display from across the network, and everyone will love the contemporary design that makes this latest MFP a perfect choice for any modern office.

It can also be supplied with Sharp OSA® (Open Systems Architecture), which gives you access to a wide range of third party software solutions that can automate many manual office tasks, such as the storing and management of documents, or the processing of forms.

Designed with the environment in mind

As well as being equipped with a manual power save button, to save energy and reduce running costs, the Energy Star certified MX-M283N benefits from an industry-leading design that cuts night energy consumption right down to a single watt - all that's needed to receive faxes.

Just as much care has been taken with manufacturing processes and materials. The environmentally- and user-friendly MX-M283N is fully RoHS-compliant and completely free from harmful chromium and lead.





Retractable Keyboard

MX-M283N - Key Features

Highly Productive Operation

- Speedy output of max. 28 ppm and fast first copy time of 4.6 sec.
- Finishing options include bi-folding saddle stitch finisher and inner finisher
- Built-in stackless duplex module and 100-sheet high-speed Reversing Single Pass Feeder
- 50 opm scan speed for one-sided originals in colour and B/W
- Standard hard disk and electronic sorting
- Standard 1,100-sheet paper capacity, expandable to max. 5,600 sheets
- Network tandem function doubles output speed by linking two MFPs
- Job Build function for large-volume documents

All-in-One Performance

- Supports Gigabit Ethernet and the latest network protocols and operating systems
- Standard PCL5e/PCL6 and optional PS3 emulation
- Full-colour network scanning with scan to e-mail/FTP server/desktop/network folder/USB, and support for JPEG, TIFF, XPS, PDF, and high-compression PDF¹ formats
- USB port at the front of the MFP allows easy scan to/print from USB memory
- Sharpdesk for integrated, intuitive document management on a PC
- Document Filing function to instantly reuse job data stored on the HDD
- Optional Super G3 fax and Internet fax that supports direct SMTP
- LDAP support for easy browsing of e-mail addresses and fax numbers
- Supports the XPS format (standard for scanning; optional for printing)

Multi-Layered Security Solutions

- Optional Data Security Kit encrypts and erases data retained inside the MFP
- Supports the IEEE 802.1X standard for port-based network access control
- Function-specific user authentication
- External Active Directory server allows user authentication management of multiple MFPs and of a greater number of users
- IP/MAC address filtering restricts unauthorised access
- SSL and IPsec enable data encryption for secure network communications
- Encrypted PDF with password protection for secure scanning
- Document Control function² prevents unauthorised copying, scanning, faxing, and filing of confidential documents

Sharp's One-of-a-Kind Features

- Sharp OSA (Open Systems Architecture)³ allows integration with network applications and makes them accessible from the LCD control panel
- 8.5-inch, touch-screen colour LCD provides thumbnails/previews of Document Filing and fax reception data and previews of copy/send/save jobs
- Control panel can be remotely displayed and operated on a PC
- Retractable QWERTY keyboard (option) allows easy text entry

Environmentally Advanced Design

- Lead- and chromium-free design (RoHS compliant)
- Certified for Energy Star
- Energy-saving design (less than 1W in standby for fax reception)

Superb Image Quality

- True 1,200 x 1,200-dpi high-quality printing without sacrificing speed
- High-resolution imaging with 256-level greyscale; clearly reproduces fine lines, small text, and delicate halftones
- Digital auto exposure control and Text/Photo mode provide optimum copy quality

¹ Requires optional MX-EBX3

² Requires optional Data Security Kit

³ Requires optional MX-AMX2 and/or MX-AMX3





**High Quality
Printing**
1200 x 1200 dpi



**High Capacity
Finisher**

Superior printing

With a fast print speed of 28 pages per minute (ppm) - even at its maximum true 1200 x 1200 dpi print resolution - everyone on the team gets the power and performance they need for the job. But that's just the start: the MX-M283N comes with a full range of advanced features and options to help raise office productivity to unprecedented levels.

A generous 80 GB hard drive and powerful processor make light work of even the most complex jobs and you can expand the standard 1,100-sheet paper capacity right the way up to 5,600 sheets for longer uninterrupted printing. And when times get busy, you can even split jobs between two MFPs for twice the speed and capacity.

Sophisticated finishing options

Now you can add authority to your documents with a range of options that will sort, fold and staple the pages just as you need them. Choices include a space-saving internal finisher for simple sorting, stapling and off-set stacking, and a hole puncher.

You can also specify a bi-folding saddle stitch finisher for folding and stapling multi-page documents into booklets, and you can add a high-capacity 4,000-sheet finisher that's perfect for document-intensive environments.

Special applications

Other useful features give you the convenience of printing directly from USB memory sticks, the ability to print 'proof sets' before committing to long print runs, and other time-saving capabilities such as direct printing from web pages, email attachments and FTP servers.

At a glance

- Fast, **28 pages per minute** print speed.
- **Superb 1200 x 1200 dpi resolution**, even at maximum print speeds.
- **Stackless duplex module** saves you filing space and money.
- **Network printing supports Gigabit Ethernet** and the most commonly used network operating systems and protocols.
- **USB memory direct printing** - conveniently print data directly from most USB memory devices, without the need for a PC.
- **XPS/PDF/TIFF/JPEG direct print**^{*1} - save time by printing XPS, PDF, TIFF or JPEG files without using the printer driver, either by calling and printing the file directly from an FTP server, direct printing from a Web page, or direct printing of e-mail attachments.
- **Standard PCL5e and PCL6** and optional PS3 emulation.^{*2}
- **Network tandem function** - double the effective output speed by sharing jobs between two MFPs on the same network.
- **Proof printing** - check a trial set before printing out a multi-page document in large numbers.
- **Barcode font print compatibility**.^{*3}

^{*1} Requires optional MX-PKX1 for PDF direct printing and MX-PUX1 & MX-SMX3 for XPS. May not support all formats

^{*2} Requires optional MX-PKX1

^{*3} Requires optional AR-PF1

Finishing Options



(10Base-T/100Base-TX/1000Base-T)



- Windows NT® 4.0, Windows Server™ 2003/2008
- Windows® 98/Me, Windows® 2000/XP/Vista
- Macintosh, Novell, UNIX, AS400



**100-Sheet
RSPF**

**Fast First Copy
4.6 Seconds**



Easy, efficient **copying**

Everything about this latest MFP has been optimised for speed, efficiency and ease of use. Not only does it copy just as quickly as it can print but it has a first-copy-out time of just 4.6 seconds.

The quality is exactly what you've come to expect from Sharp. The 1200 x 1200 dpi resolution is supported by a 256-level greyscale for reproducing fine lines and delicate halftones; digital auto exposure control delivers optimum copy contrast, and selectable text and photo modes ensure accurate copies every time.

The MX-M283N will help to keep everyone productive, too, with a whole range of advanced copy functions that delivers exceptional versatility. Book Copy, for example, is great for compiling copies of a book (or other bound original) directly into pamphlet format. The Card Shot feature lets you copy both sides of a card, such as an ID card or licence, on to one page in a one-touch operation, and the Tab Copy/Print function makes it easy to copy or print directly on to the tabs on document separators.

At a glance

- **Fast first copy time** of just 4.6 seconds.
- **High-speed 100-sheet A3 Reversing Single Pass Feeder (RSPF)** for quick and easy single and double-sided copying.
- **Mixed Size Original Copy mode** automatically recognises documents of different sizes and chooses the appropriate paper.
- **Electronic sorting and offset stacking** with space-saving inner finisher to keep jobs separate.
- **Job Build function** for easier management of large, multi-page jobs even if they exceed the capacity of the RSPF.
- **Image editing functions**, including multi-shot, multi-page enlargement, image repeat and mirror image for extra versatility.
- **Proof copy function** lets you produce a test set of documents before committing to a long run.
- **Cover/transparency insertion** for the effortless creation of professional-looking documents.

with **Colour Network Scanning**





Scan to Email,
Network, PC,
FTP or USB



Retractable
Keyboard

Fast colour network scanning

The new MX-M283N can easily take care of your day-to-day scanning needs, handling up to 50 single-sided originals per minute, or 20 two-sided originals.

A retractable keyboard option makes it easy to add data to scanned documents and to select multiple destinations including email recipients, network folders, FTP servers, your desktop, or a USB memory stick. You can also scan documents directly to a choice of formats including XPS, JPEG, TIFF and PDF, as well as the High-Compression PDF format*¹ for smaller files, faster transfers and lower network overheads.

At a glance

- **Full-colour scanning** to your PC, e-mail recipients, FTP servers, network folders, or a memory stick that plugs into an easily accessible USB port.
- **Retractable keyboard** for easy data entry.
- **RSPF scans at speeds of 50 originals per minute (opm)** or 20 opm for two-sided scanning.
- **Mixed-size original scanning** automatically accommodates documents of different sizes.
- **Compatible with TWAIN-compliant** network applications.
- **Includes Sharpdesk™** document management software.
- **Lightweight Directory Access Protocol (LDAP)** allows easy browsing of e-mail addresses for rapid distribution of scanned documents, as well as automatic synchronisation with your primary e-mail server.
- **Scan directly** to XPS, TIFF, JPEG, PDF, encrypted PDF and High-Compression PDF*¹

*¹ Requires optional MX-EBX3

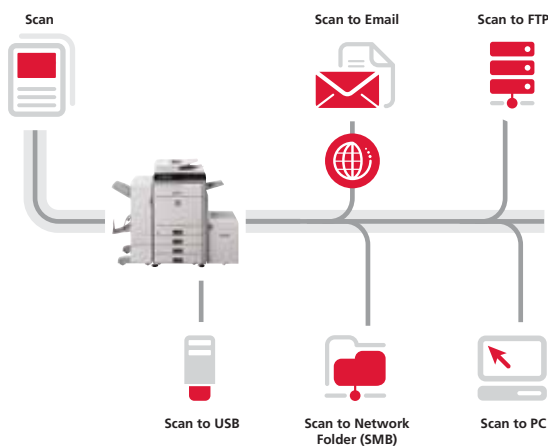



**Automated
Finishing**

**Fax
Thumbnail**

Versatile faxing

You can extend the functionality of the MX-M283N even further by specifying the optional fax expansion kit. Documents can either be scanned and sent over ultra-fast 33,600 bps Super G3 fax, or you can simply send digital files directly from your PC with the PC-Fax/PC-Internet Fax function.*1

When faxes arrive, they can be automatically routed to a mailbox without being printed and you can view preview images to help you decide which ones you need a hard copy of.

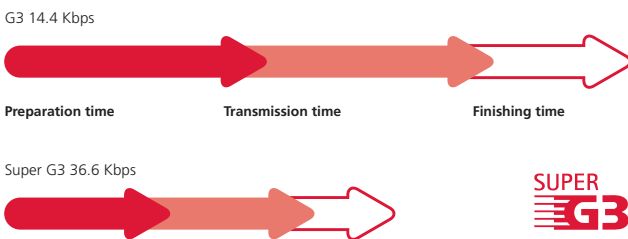

At a glance

- **Send or receive single- or double-sided faxes** up to A3 in size.
- **Super G3/JBIG compression** for extra speed and online transmission for faster operation.
- **Transmits faxes** in less than three seconds.
- **One-touch dialling** of up to 1,000 stored numbers.
- **Can broadcast faxes** to as many as 500 destinations.
- **Paperless faxing with inbound routing and thumbnail previews** lets you decide which faxes to print.
- **Flash memory** prevents data loss in a power failure.
- **Duplex faxing** lets you scan and send two-sided documents and print incoming faxes onto both sides of paper.
- **Internet fax***1 with Direct SMTP support means that outgoing internet faxes do not go via the mail server, making transmission faster and cheaper.
- **PC-Fax/PC-Internet Fax***1 lets you send data directly from a PC to a fax machine without printing to paper.
- **Fax Destination Confirmation** prevent transmission errors by letting you reconfirm fax numbers before sending.

*1 PC-Fax requires optional MX-FXX2 and PC-Internet Fax requires optional MX-FWX1

Automated fax finishing

A built-in duplex module saves resources by automatically printing inbound faxes on both sides of the page; you can set the machine to automatically make copies for distribution, and if you have the optional finisher installed it will even staple multi-page faxes to keep them organised.

with **Colour Network Scanning**





Image
Preview/
Thumbnail



Sharp OSA®

Powerful document management

Your new Sharp MFP comes complete with everything you need to manage your document workflow. An 80 GB integrated hard drive gives you plenty of space to save scanned files for future retrieval and you can even store and repeat entire print runs without recreating the job.

Up to **3,000 files or 20,000 pages***¹ of copy, print, scan, and fax*² data can be filed in up to **1,000 shared, long-term storage in folders**, and up to **1,000 files or 10,000 pages***¹ placed in **temporary storage** for repeating jobs without having to recreate them. To access them, simply browse the thumbnail previews on the LCD panel, make a selection and enter your PIN.

Easy document management with Sharpdesk™

Sharpdesk document management software is a desktop-based solution that's capable of handling more than 200 different file formats. It lets you browse, sort, search and share files as well being able to create documents that combine scanned and operator-created data.

- Intuitive desktop display features **thumbnail viewing**.
- Sharpdesk Imaging provides **annotation tools** for paper-free proofreading.
- Sharpdesk **Composer** combines different types of files into a single document.
- **Optical character recognition** converts documents into editable text files.
- **Output zone** distributes files to e-mail, printers and other applications.
- **File search** allows searching by file name, keyword or thumbnail.



Sharp OSA® (Open Systems Architecture)

You can enhance the productivity of the MX-M283N still further, thanks to Sharp OSA (Open Systems Architecture) which lets 3rd party developers directly integrate the MFP with your business applications. There are three optional Sharp OSA modules:

- **Application Integration Module (MX-AMX1)** – lets users add data to scanned documents before sending them directly to applications for processing and archiving.
- **Application Communication Module (MX-AMX2)** – lets remote applications create, configure, and execute scanning and printing jobs on the MFP.
- **External Account Module (MX-AMX3)** – tracks usage by individuals and workgroups and restricts usage according to individual access rights.

*¹ Measured using Sharp's standard chart (A4 with 6% coverage, B/W). The Quick File Folder shares the HDD with the Job Build function; up to 12GB of data storage is available when using both functions. The storage capacity will be less for colour pages.

*² For fax and Internet fax jobs, only transmitted data (not received faxes) can be saved in the Document Filing function.





Printer Administration Utility



Remote Front Panel

Integrated device management

Like all Sharp MFPs, the MX-M283N is easy to configure and support, and multiple devices can be managed from a single remote location. The result is minimum time and effort for maximum work efficiency.

Web-based system settings

Administrators can configure important system settings such as address book control, document filing management, and operator access control from across the network as well as from the front control panel.

Access control

You can keep control of running costs by restricting who can use the MFP and for what purpose, giving permission to carry out long print or copy runs to specific individuals only, for example.

Access and usage rights can be set up for different workgroups and departments, with further control achieved through the configuration of up to 1,000 password-protected user accounts with customised settings.

Remote diagnosis

The MX-M283N can be monitored remotely through a web browser and conditions such as 'Low Toner' will appear on the MFP's web page. In addition, features such as E-Mail Status and Alert will automatically create and send email alerts when corrective action or maintenance is required.

Network utility software

Sharp's Printer Administration Utility (PAU), supplied as standard, makes the configuration of printers and MFPs quicker and easier than ever before. With PAU, you can monitor any SNMP-compliant printer on the network, without ever leaving your desk and enjoy complete, real-time control of your printer fleet through any standard web browser. Error-reporting, technical support, driver installation, printer configuration: everything is easier and more accessible.

Another network utility, **Sharp Printer Status Monitor**, lets people check the MFP's operating status, toner levels, paper supplies and features before they start a job, as well as displaying an icon on the desktop when the work has been completed and the documents are ready for collection.

Device cloning for rapid deployment

It is quick and easy to deploy Sharp MFPs. Simply set up the first one, copy its settings and then transfer the entire configuration to each additional machine via a web browser. For extra convenience, you can edit the settings before transferring them.

Remote operation for easier support

The remote access interface saves time and effort while minimising downtime by letting your support staff view and operate the MFP's control panel without leaving their desks. The support technician simply opens a web browser and either fixes the problem directly or gives step-by-step training to the operator to achieve the same result.





Data Security Kit

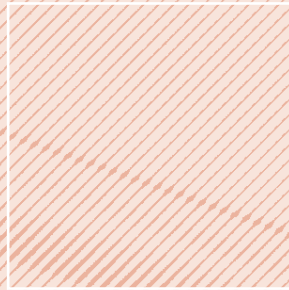

Document Control

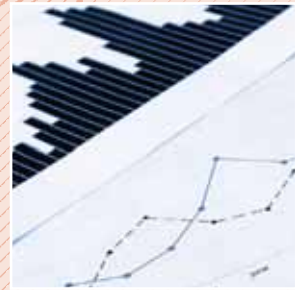

Industry-leading multi-layer security

The MX-M283N safeguards sensitive data with powerful encryption technology and advanced security functions that provide multiple levels of network and data security.

Document Control Function

Document Control^{*1} prevents the unauthorised copying, scanning, faxing and filing of confidential documents by adding copy-prevention data to a document when it is first copied or printed. If someone subsequently tries to make a copy of the document, the MFP detects this data and cancels the job or outputs a blank page.^{*2}

Data Security Kit

Digital copiers, printers and MFPs can retain hundreds of pages of confidential information from previous jobs on their hard disks or internal memory. To protect this information from unauthorised access, the optional Data Security Kit automatically encrypts the data or securely erases it on completion of the job. It also encrypts the address book.

At a glance

- **Data Security Kit^{*1}** encrypts data on the hard disk and internal memory, removing it safely and completely after use.
- **Secure Network Card** provides network port and protocol management to prevent direct connection and access by unauthorised users.
- **Secure Sockets Layer (SSL) and IPsec** encrypts data communications to prevent data leakage through the network.
- **Encrypted PDF** with password protection prevents unauthorised viewing of confidential image data.
- **Document Control^{*1}** prevents unauthorised copying, scanning, faxing and filing.
- **Supports IEEE 802.1X standard** for port based network control.
- **User authentication** requires logging into the machine with passwords for machine access.
- **Confidential data storage** and printing protects sensitive information by requiring the user to enter a PIN code before the documents are produced.
- **Secure data storage for Document Filing^{*1}** - all data that goes through the hard disk is encrypted, while passwords used in the Advanced Filing function ensure solid security.^{*3}

^{*1} Requires optional Data Security Kit. Document Control Function may not work for certain types of documents and paper.

^{*2} May also output a blank page if paper has already been fed for the job before the MFP detects the copy prevention data.

^{*3} Password Protection is provided as standard. Encryption is optional.

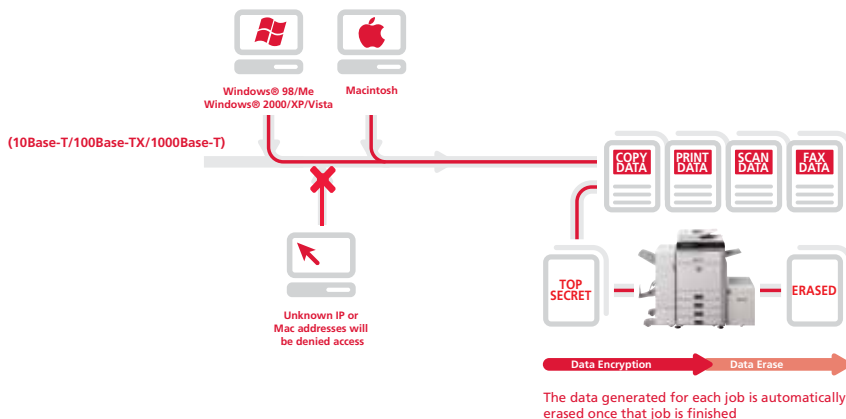



Finishing Options



Connectivity Options

MX-M283N - Options



Finishing

1. MX-FNX9 Finisher

A3 to B5 (offset/staple), A3W to A5R (non offset)
Offset tray (upper): max. 500-sheet paper capacity^{*1}
Stapling capacity: max. 50-sheet multi-position staple^{*1}
Staple position: 3 locations (front, rear or 2 point stitching)^{*1}

Optional Punch Module for MX-FNX9

MX-PNX1A - 2 Hole Punch Module
MX-PNX1C - 4 Hole Punch Module
MX-PNX1D - 4 Hole Wide Punch Module

2. MX-FN10 Saddle Stitch Finisher (1,000-Sheet)

A3 to B5 (offset/staple), A3W to A5R (non offset)
Offset tray (upper): max. 1,000-sheet paper capacity^{*1}
Stapling capacity: max. 50-sheet multi-position staple^{*1}
Staple position: 3 locations (front, rear or 2 point stitching)^{*1}
Saddle stitch tray (lower): 10 sets (11-15 sheets), 15 sets (6-10 sheets), 20 sets (1-5 sheets). 15 sheets max per set.

Optional Punch Module for MX-FN10

MX-PNX5A - 2 Hole Punch Module
MX-PNX5C - 4 Hole Punch Module
MX-PNX5D - 4 Hole Wide Punch Module

3. MX-FN11 High Capacity Finisher (4,000-Sheet)

A3 to B5 (offset/staple), A3W to A5R (non staple/offset)
Upper tray max. 1,550 sheets capacity^{*1}
Lower tray max. 2,450 sheets capacity^{*1}
Stapling capacity: max. 50-sheet multi position staple^{*1}
Staple position: 3 locations (front, rear or 2 point stitching)^{*1}

4. Optional Punch Module for MX-FN11

MX-PNX6A - 2 Hole Punch Module
MX-PNX6C - 4 Hole Punch Module
MX-PNX6D - 4 Hole Wide Punch Module

5. MX-RBX3 Paper Pass Unit

Required when using MX-FN10 or MX-FN11

6. MX-TRX2 Exit Tray Unit

Base Unit

7. MX-DEX9 Stand with 2 x 500 Sheet Paper Drawers

A3 to B5R, 500 sheets each (80 g/m²) for lower and upper trays

8. MX-DEX8 Stand with 500 Sheet Paper Drawer

A3 to B5R, 500 sheets (80 g/m²)

9. MX-DK131 Cabinet

10. MX-LCX1 3,500 Sheet Large Capacity Tray
A4 or B5, 3,500 sheets (80 g/m²)

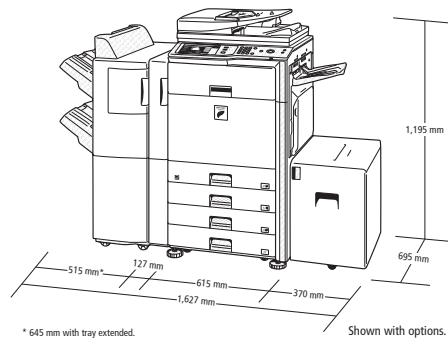

* 645 mm with tray extended.

Shown with options.

^{*1} A4 or smaller, 80g/m²

^{*2} Available at a later date

Connectivity Board

MX-KBX2 Keyboard

MX-SMX3 Expansion Memory Board (1GB)

Printing

MX-PKX1 PS3 Expansion Kit

Enables PostScript printing

MX-PUX1 XPS Expansion Kit

(MX-SMX3 is required)

AR-PF1 Barcode Font Kit

Faxing

11. MX-FXX2 Fax Expansion Kit

Super G3 fax module

MX-FWX1 Internet Fax Expansion Kit

Scanning

AR-SU1 Stamp Unit

Marks already scanned documents for checking

MX-EBX3 Enhanced Compression Kit

Sharpdesk™ Licenses

MX-USX1 x 1 user

MX-USX5 x 5 users

MX-US10 x 10 users

MX-US50 x 50 users

MX-USA0 x 100 users

Security

MX-FR14U Data Security Kit Commercial Version^{*2}

MX-FR14 Data Security Kit Common Criteria Certified^{*2}

Sharp OSA®

MX-AMX1 Application Integration Module

MX-AMX2 Application Communication Module

MX-AMX3 External Account Module

Some options may not be available in some areas



Specifications

MX-M283N

Digital Multifunctional System



General		
Engine speed (max.)	A4 28 ppm/cpm	A3 15 ppm/cpm
Paper size	Max. A3W (via bypass), min. A5R	
Paper capacity	Standard: 1,100 sheets (2 x 500-sheet drawer and 100-sheet multi-bypass tray) Maximum: 5,600 sheets (4 x 500-sheet drawer, 3,500-sheet large capacity tray and 100-sheet multi-bypass tray)	
Paper weight	Drawer: 60 g/m ² – 209 g/m ² Large-capacity tray: 60 g/m ² – 105 g/m ² Multi-bypass tray: 56 g/m ² – 209 g/m ²	
Warm-up time	Less than 20 sec.	
Memory	(Copier) Standard 640MB (Printer) Standard 1GB, Maximum 2GB 80GB HDD ^{*1}	
Power requirement	Rated local AC voltage ±10%, 50/60 Hz	
Power consumption (max.)	1.84 kW (220 to 240V)	
Dimensions (W x D x H)	645 x 695 x 935 mm	
Weight (approx.)	95 kg	

Copier	
Original paper size	Max. A3
First copy time^{*2} (sec)	4.6
Continuous copy	Max. 999 copies
Resolution (max.)	1,200 x 1,200 dpi, 600 x 600 dpi
Gradation	Equivalent to 256 levels
Zoom range	25 to 400% (25 to 200% using RSPF) in 1% increments
Preset copy ratios	10 ratios (5R/5E)

Network Colour Scanner	
Scan method	Push scan (via control panel), pull scan (TWAIN-compliant application)
Resolution	Push scan: 100, 200, 300, 400, 600 dpi Pull scan: 75, 100, 150, 200, 300, 400, 600 dpi 50 to 9,600 dpi via user setting
File formats	TIFF, PDF, encrypted PDF, JPEG (colour only), XPS ^{*3} , high-compression PDF ^{*4}
Scanner utility	Sharpdesk
Scan destinations	Scan to e-mail, desktop, FTP server, network folder (SMB), USB memory

Document Filing	
Document filing capacity	Main and custom folders: 38GB, 20,000 pages ^{*5} or 3,000 files Quick file folder: 12GB, 10,000 pages ^{*5} or 1,000 files
Stored jobs	Copy, print, scan, fax transmission ^{*6}
Storage folders	Quick file folder, main folder, custom folder (max. 1,000 folders)
Confidential storage	Password protection

Network Printer	
Resolution	1,200 x 1,200 dpi, 600 x 600 dpi
Interface	USB 2.0 10Base-T/100Base-TX/1000Base-T
Supported OS^{*7}	Standard: Windows NT [®] 4.0 SP5 or later, Windows Server [®] 2003/2008, Windows [®] 98/Me/2000/XP, Windows Vista [®] Optional: Mac OS 9.0 – 9.2.2, Mac OS X 10.2.8, 10.3.9, 10.4.11, 10.5 – 10.5.5
Network protocols^{*7}	TCP/IP (IPv4, IPv6), IPX/SPX (NetWare), NetBEUI, EtherTalk (AppleTalk)
Printing protocols	LPR, Raw TCP (port 9100), POP3 (e-mail printing), HTTP, Novell Printserver application with NDS and Bindery, FTP for downloading print files, EtherTalk printing, IPP
PDL (emulation)	Standard: PCL 6/5e emulation Option ^{*8} : PS3 emulation, XPS
Available fonts	80 fonts for PCL, 136 fonts for PS3 emulation

Facsimile (optional MX-FXX2 required)	
Compression method	MH/MR/MMR/JBIG
Communication protocol	Super G3/G3
Transmission time	Less than 3 seconds ^{*9}
Modem speed	33,600 bps to 2,400 bps with automatic fallback
Transmission resolution	Standard: 203.2 x 97.8 dpi Super Fine: 406.4 x 391 dpi
Recording width	A3 to A5
Memory	8MB flash memory
Grey scale levels	Equivalent to 256 levels



* 1: HDD capacity depends on procurement and sourcing status. * 2: Long-edge feeding of A4 sheets. May take longer when taking a copy for the first time immediately after turning the machine on. * 3: To view XPS files on PCs not running Windows Vista, you must have the XPS Viewer application installed. * 4: Optional MX-EBX3 required. * 5: Measured using Sharp's standard chart (A4 with 6% coverage, B/W). The Quick File Folder shares the HDD with the Job Build function; up to 12GB of data storage is available when using both functions. The storage capacity will be less for colour pages. * 6: Optional MX-FXX2 required. * 7: Optional MX-PKX1 required for Mac OS and EtherTalk. * 8: PS requires optional MX-PKX1. XPS requires optional MX-PUX1 and MX-SMX3 (1GB). * 9: Based on Sharp's standard chart with approx. 700 characters (A4 long-edge feeding) at standard resolution in Super G3 mode, 33,600 bps, JBIG compression.

SHARP

Design and specifications are subject to change without prior notice. All information was correct at time of print. The ENERGY STAR logo is a certification mark and may only be used to certify specific products that have been determined to meet the ENERGY STAR programme requirements. ENERGY STAR is a US registered mark. Windows, Windows NT, Windows XP and Windows Vista are registered trademarks of Microsoft Corporation. SAP and all SAP logos are trademarks or registered trademarks of SAP AG in Germany and in several other countries. Citrix is a trademark of Citrix Systems, Inc. and/or one or more of its subsidiaries, and may be registered in the United States Patent and Trademark Office and in other countries. All other company names, product names and logotypes are trademarks or registered trademarks of their respective owners. ©Sharp Corporation 2009. Ref: M283N All trademarks acknowledged. E&OE.